

# Compliance Tips

## Considerations for handrail compliance to meet AS1428.1-2021

The design and construction of handrails shall comply with the following:

- a) Handrails and balustrades shall not encroach into required circulation spaces.
- b) The cross-section of handrails shall be circular or elliptical, not less than 30 mm or greater than 50 mm in height or width for not less than 270° around the uppermost surface as shown in Figures 29(a) and 29(b).

Elliptical handrails shall have the greater dimension in the horizontal axis as shown in Figure 29(b).

- h) The clearance between a handrail and an adjacent wall surface or other obstruction shall be not less than 50 mm.

This clearance shall extend above the top of the handrail by not less than 600 mm.

- i) Handrails shall have no obstruction to the passage of a hand along the rail, as shown in Figures 29(a) and 29(b).

Figure 29 (in part) Handrails

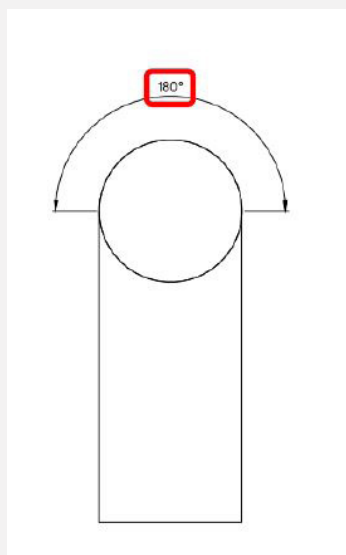
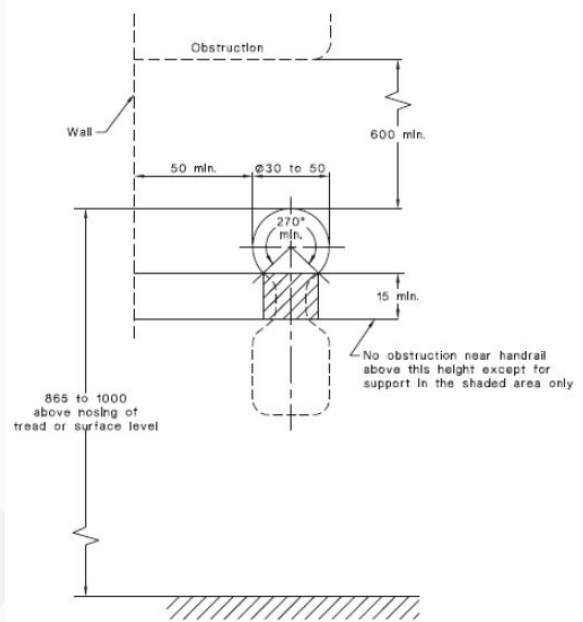

**Notched and Welded**

- ✗ Non-compliant
- Less than 270° clearance

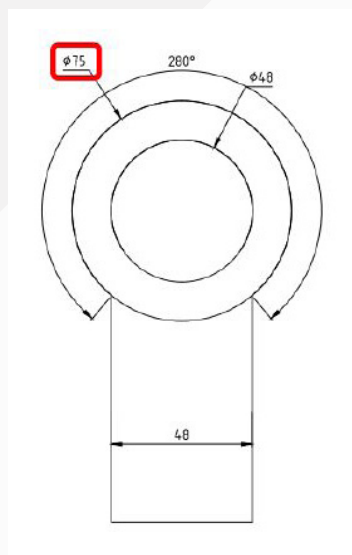

**Ball and Tube**

- ✗ Non-compliant
- Greater than 50mm diameter at connection creating an obstruction

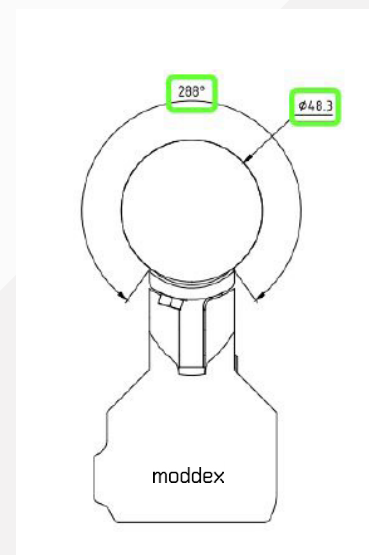

**Moddex Proprietary System**

- ✓ Compliant
- Meets all requirements